

THESE INSTALLATION INSTRUCTIONS ARE FOR THE UNIPUSH LOCKING SYSTEM ONLY



ATTENTION! READ BEFORE INSTALLING!

INSTALLER – HOMEOWNER RESPONSIBILITY

This product may have very high color/character variation. Work out of several cartons simultaneously during installation. When finished moldings are required for the project, pre-select the plank(s) that best coordinates with the color of the adjacent molding piece(s).

FOR BEST VISUAL REPRESENTATION OF YOUR FLOOR

This flooring replicates the look of a natural product which has natural variations in color and texture. For best visual effect, shuffle planks from several cartons and do not install similar boards next to one another.

SUBFLOOR PREPARATION

Subfloor should be dry and level to 3/16" per 10 ft. radius for best installation results. Vinyl flooring should only be used indoors.

FLOORING MATERIAL SHOULD BE INSPECTED PRIOR TO INSTALLATION

Responsibility for the suitability of Manufacturer flooring and accompanying products for each individual installation cannot be assumed by Manufacturer, since Manufacturer has no control over the installer's proper application. Sample Boards may not always match the flooring due to light conditions therefore, the homeowner should always be present when the installation takes place. Should an individual plank or tile be doubtful as to appearance or dimension the installer should not use this piece. Once a plank is installed it is deemed acceptable by a Homeowner/Installer. Always inspect material from different angles, any visual imperfection is part of the realistic wood look decor style.

NOTE: Manufacturer flooring with attached underlayment CANNOT be installed with a glue-down method.

READ BEFORE INSTALLING

While flooring is waterproof, it's not a moisture barrier. Concrete should always be cured and tested for moisture and a moisture barrier should always be installed in the crawl space and even under the floor over a concrete sub-floor. Please refer below for further guidance.

Please check for defects, squeaky noises, sub-floor issue or finish issues by installing 100 sq. ft. of flooring. Because houses and buildings, as well as adjacent hardwood or laminate floors, expand and contract, Manufacturer recommends leaving a 1/4" expansion gap between the perimeter walls and any adjacent hardwood floor. Do not install floors where it will be exposed to temperatures greater than 140° F. Use good common-sense installation practices, and you'll have a successful installation that results in a beautiful floor. Check that all ITEM NUMBERS are the same and that you have purchased sufficient packs to complete the job.

KEYS TO SUCCESSFUL LOCKING INSTALLATION

All planks should be checked before and during installation for faults which are clearly visible; this will reduce problems when assembling and identify any color differences. The inspection should be performed in daylight, or under good artificial lighting, in the room in which the products are to be installed. If flooring is not acceptable, contact your supplier immediately and arrange for replacement. Manufacturer cannot accept responsibility for flooring installed with visible defects. Prior to installation of any flooring, the installer must ensure that the job-site and sub-floor meet the requirements of these instructions. Manufacturer is not responsible for flooring failure resulting from unsatisfactory job-site and/or sub-floor conditions. Flooring should be one of the last items installed in any new construction or remodel project.

CRAWL SPACES

Crawl spaces must be a minimum of 18" (46 cm) from the ground to the underside of the joists. A ground cover of 6-20 mil black polyethylene film is required as a vapor barrier with joints lapped 6" (15 cm) and sealed with moisture resistant tape. The crawl space should have perimeter venting equal to a minimum of 1.5% of the crawl space square footage. These vents should be properly located to foster cross ventilation. Local regulations prevail where necessary.

WASTE

Most installations will need approximately a 10% cutting and waste allowance added to the square footage of the room.

TEMPERATURE & HUMIDITY

Room temperature and humidity of installation area should be consistent with normal, year-round living conditions for at least one week before installation of flooring. Maintaining an optimum room temperature of 70° F and a humidity range of 40-55% is recommended throughout the space.

STORING

Proper conditioning of the job site is necessary. Flooring planks should not be exposed to sudden changes in temperature. Store, transport and handle the flooring planks in a manner to prevent any distortions. Distortions will not disappear over time. Store cartons flat, never on edge. Insure that the flooring planks are lying flat at time of installation.

TRANSITIONS

When installing next to other types of flooring use a transitions strip/molding. Installations of carpet, tiles, metal strips and other transition moldings should not push fully into the flooring and should allow for some slight movement wherever practical.

ROOMS LONGER THAN 50'

For rooms, wider or longer than 50', the use of T-moldings is required to account for the normal movement or seasonal expansion/contraction of the floor. If the homeowner does experience gapping then we would suggest the contractor tap the planks back together since they may come apart for longer run lengths. Protect the floor from heavy-rolling loads, other trades, and movement of appliances by using sheets of plywood or similar.

SUITABLE SUBSTRATES

All substrates listed below must be properly prepared and meet certain requirements. There may be other exceptions and special conditions (as noted below) for these substrates to be suitable for the locking installation system.

- Concrete – dry and smooth on all grade levels and must remain dry year-round.
- Suspended wood sub-floors with approved wood underlayments – must have minimum of 18" well-ventilated crawl space underneath
- Suspended hardwood flooring that is fully adhered, smooth and square edge without texture
- Single-layer, fully-adhered, existing resilient floors – must not be foam-backed or cushion backed
- Ceramic tile, Terrazzo, Marble
- Polymeric Poured (seamless) Floors
- Use Ply-Wood/OSB - 3/4 "
- Particleboard 40lb. density or wafer board

DO NOT INSTALL OVER

- Existing resilient tile floors that are below grade
- Existing cushion-backed vinyl flooring
- Carpet
- Hardwood flooring that has been installed directly over concrete
- On stairs or in rooms with sloping floors or floor drains

SUCCESSFUL WAYS TO AVOID MOVEMENT OR NOISE

Squeaking and clicking noises can be a result of many causes putting stress on the locking system;

- Locking system not engaged completely on both short and long joints. To avoid this make sure to use a rubber mallet to engage each plank together and test each row. Please note not to use excessive force or the profile will break.
- Do NOT use improper underlayment. (Please contact manufacturer to confirm underlayment).
- Joist/sub-floors moving which cause squeaky noises.
- Do NOT use any end joint that are broken (during transit or installation).
- Provide a minimum .25" on each wall space for expansion. (Lack of proper expansion space can cause peaking/tenting on the end joints).
- Confirming that floor is flat before installation. (Sub-floor deflection is not within manufacturer tolerance and the floor is not flat).
- Do NOT install floors in an extreme environment.

In order to minimize squeaking or noise complaints please make sure all points above are met during installation.

PRE-INSTALLATION SUBFLOOR REQUIREMENTS

All Sub-floors must be:

- Dry The subfloor must be FLAT, SECURE, and DRY. We recommend the use of a moisture barrier vapor protection against future water from floods and ground swell. 6 mil polyfilm is a suitable moisture barrier which should be overlapped six inches and taped at the seams. Sounds produced between the subfloor and moisture barrier are considered a subfloor issue and are not covered under the product warranty. Subfloors with high moisture trapped underneath the flooring can create pressure at the seams resulting in cupping. It can take several months for the cupping to become apparent after high moisture in the subfloor exists or flooding occurs, and such conditions are NOT covered under this products warranty.
- Structurally sound
- Clean: Thoroughly swept and free of all debris
- Level: Flat to 4.7mm (3/16") per 3.3 meters (10-foot) radius

WOOD SUB-FLOOR

Wood sub-floors must be dry and well secured. Nail or screw every 6" along joists to avoid squeaking. If not level, sand down high spots and fill low spots with a Portland Based leveling patch.

CONCRETE SUB-FLOOR

Concrete sub-floors must be fully cured, at least 60 days old, and should have minimum 6-mil poly-film between concrete and ground. Sub-floor should be flat and level within 3/16" per 10' radius. If necessary grind high spots down and level low spots with a Portland leveling compound.

Ceramic Tile, resilient tile and sheet vinyl must be well-bonded to sub-floor, in good condition, clean and level. Do not sand existing vinyl floors, as they may contain asbestos. Resilient flooring should only be installed in temperature-controlled environments. It is necessary to maintain a constant temperature before, during and after the installation. Therefore, the permanent or temporary HVAC system must be in operation before the installation of resilient flooring. Portable heaters are not recommended as they may not heat the room and sub-floor sufficiently. Kerosene heaters should never be used.

All substrates must be structurally sound, dry, clean, flat, and smooth with minimal deflection. Substrates must be free from excessive moisture or alkali. Remove dirt, paint, varnish, wax, oils, solvents, other foreign matter and contaminates. High spots on the substrate should be leveled and low areas filled with appropriate underlayments. Do not use products containing petroleum, solvents or citrus oils to prepare substrates as they can cause staining and expansion of the new flooring.

RENOVATIONS OR REMODEL WORK

For renovation or remodel work, remove any existing adhesive residue so that 100% of the overall area of the original substrate is exposed. Embossed existing resilient floors, ceramic tile floors, ceramic and marble grout joints, and irregularities in concrete should be filled. Maintain temperatures between 55°F (13°C) and 85°F (29°C).

For concrete substrates, conduct moisture testing (moisture vapor emission rate {MVER}) not to exceed 5lbs and/or percent relative humidity 85% (in-situ probe). Bond tests must also be conducted for compatibility with the substrate.

PLEASE REFER TO SUB-FLOORS AND UNDERLAYMENTS

- Radiant heated substrates must not exceed a maximum surface temperature of 81°F (27 °C).
- The sub-floor panels must have a smooth, sanded face and show no swelling of edges or surface due to exposure to weather conditions or construction traffic.
- There are numerous products available for use as floor fills, patches, self-leveling underlayments, and trowelable underlayments. They include proprietary blends of compounds such as Portland cement, calcium aluminates, and gypsum based products. These are recommended for smoothing rough or uneven sub-floors, enhancing acoustical and fire characteristics of structures or as substrates to receive floor covering for otherwise unsuitable sub-floor conditions.

INSTALLATION TOOLS

For all installation methods:

- Tape measure
- Tapping block (trimmed piece of flooring)
- Pencil
- Leveler
- Rubber Mallet
- 1/4" Spacers
- Pry bar or pull bar
- Chalk line
- Crosscut power saw

Acceptable sub-floor types:

- CDX Underlayment Grade Plywood (at least 1/2" thick)
- Underlayment grade particleboard OSB (at least 3/4" thick)
- Concrete slab
- Existing wood floor
- Ceramic tile, Resilient tile & sheet vinyl
- 3M Scotch-Blue™ 2080 Tape

STARTING YOUR INSTALLATION

Work from several open boxes of flooring and "dry lay" the floor before permanently laying the floor. This will allow you to select the varying grains & colors and to arrange them in a harmonious pattern. Remember, it is the installer's responsibility to determine the expectations of what the finished floor will look like with the end user first and then to cull out pieces that do not meet those expectations.

Begin installation next to an outside wall. This is usually the straightest and best reference for establishing a straight working line. Establish this line by measuring an equal distance from the wall at both ends and snapping a chalk line. The distance you measure from the wall should be the width of a plank. You may need to scribe cut the first row of planks to match the wall in order to make a straight working line if the wall is out of straight.

You may want to position a few rows before starting installation to confirm your layout decision and working line. When laying flooring, stagger end joints from row to row by at least 8". When cutting the last plank in a row to fit, you can use the cut-off end to begin the next row. If cut-off end is 8" in length or less, discard it and instead cut a new plank at a random length and use it to start the next row. Always begin each row from the same side of the room. When near a wall, you can use a pry bar to pry close the side and end joints.

INSTALLATION METHOD

LVT/SPC/WPC

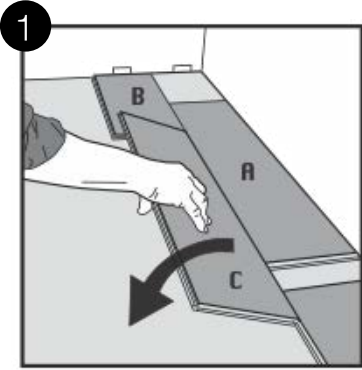

First row. Place a panel (A) as support for long side alignment of panel (B) and (C) while you install panel (B) and panel (C). Place a 10mm spacer between panel (B) and the wall. After that the complete first row is installed, remove panel (A) and slide the first row up against the wall with 10mm spacers placed between the panels and the wall. Later, after 3 rows, you can easily position the flooring against the front wall with predicted spacers.

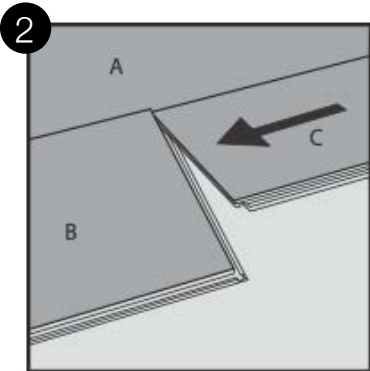

Second plank, first row.
Place this plank (C) gently close to the short end of the first one (B).

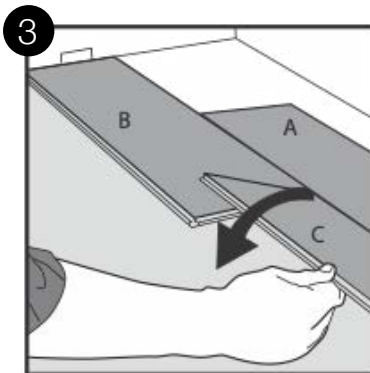

Fold it down with a single action movement. During the fold down, make sure the panels are close to each other.

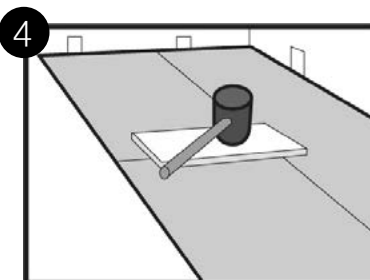

Afterwards use a tapping block and rubber mallet along both short ends to engage the planks. Place the tapping block over both short end and tap it with the mallet till the ends are engaged. Please be careful not to damage the profile or edges while engaging the planks. Test each plank before proceeding to the next row to make sure they are fully engaged.



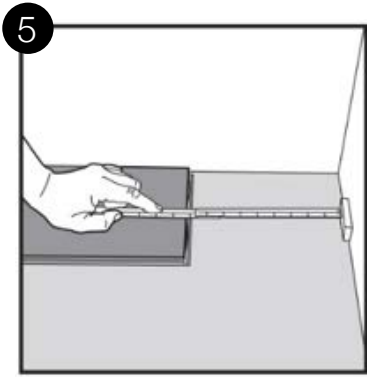

5 At the end of the first row, put a spacer to the wall and measure the length of the last plank to fit. Cut the extra material and complete the row.

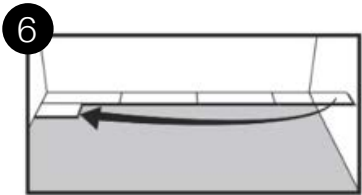

6 Second row. First plank min length 500 mm. Put a 10mm spacer against the left wall.



7 Staggered joint distance i.e. minimum distance between short ends of planks in parallel rows should NOT be less than the given width of the plank.

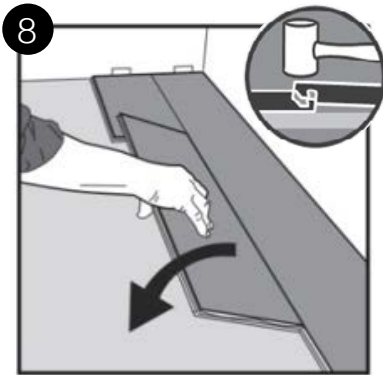

8 Second plank second row. Place the panel gently and close to the short end of the previous panel and fold it down in a single action movement reinforced with a rubber mallet as in step 4.

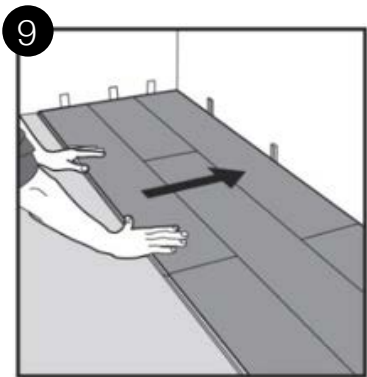

9 After 2-3 rows. Adjust the distance to the front wall by placing 10mm spacers.

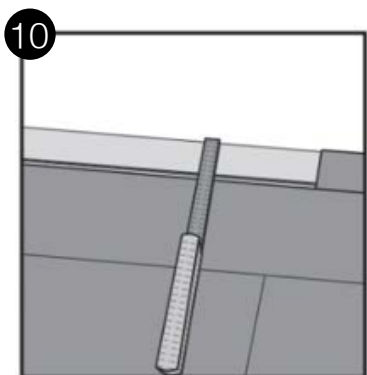

10 Last row (and perhaps also first row). Minimum width 50 mm. Place a spacer to the wall before measuring. Cut the panels lengthwise.

HORIZONTAL INSTALLATION

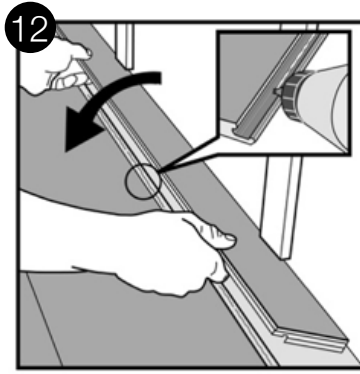
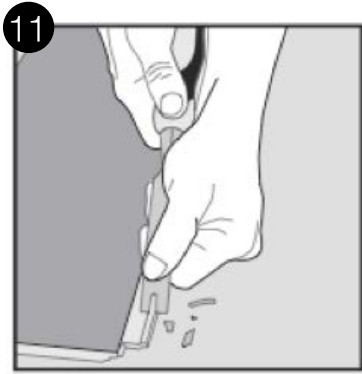

Fig 11 and fig 12. Cut off the vertical locking part of the strip with a chisel, put applicable glue on the strip and push the planks horizontally together. If necessary place some spacers between last board and the wall during the hardening.

RADIATOR PIPES

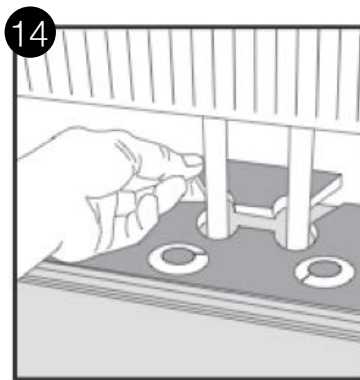
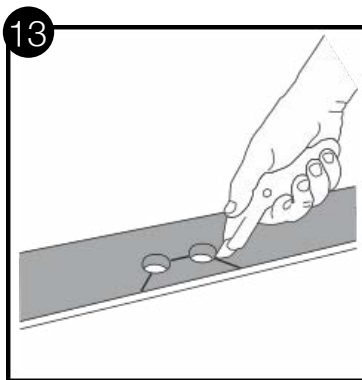
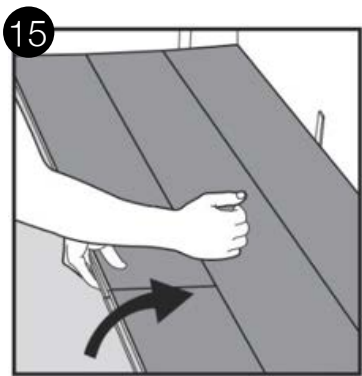

Fig 13 and 14. Installation at radiators. Drill the holes 2 x spacer thickness larger, than the diameter of the pipes.

DISASSEMBLING PANELS NEAR WALL



Separate the whole row by carefully lifting up and release the whole row. Fold up the row and release the whole long side.

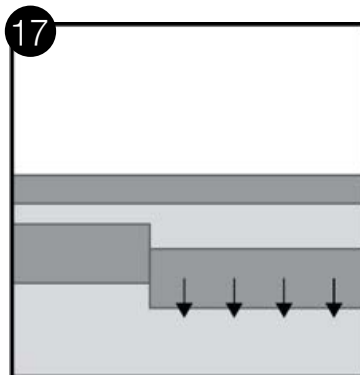
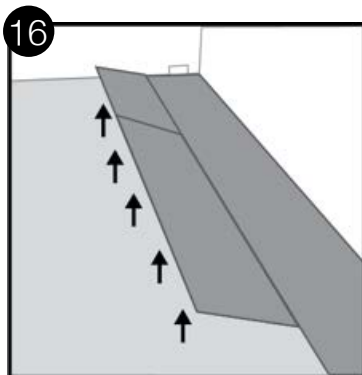
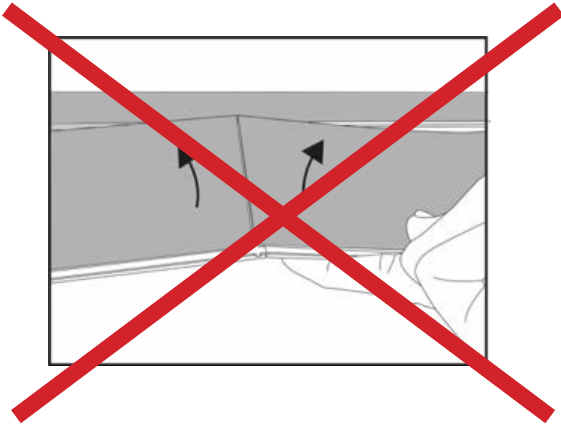
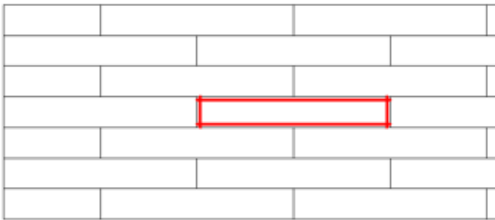

Fig 16 & Fig 17
Disassemble the panels by lifting the short ends upward and then slide. Do never fold up a panel, as this damage the profile.

HOW NOT TO DISASSEMBLE PANELS



REPLACEMENT OF A PANEL IN THE MIDDLE OF THE ROOM



Please cut the panel along the red lines as indicated below.

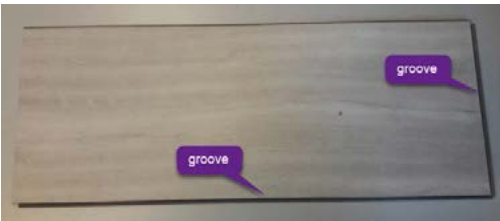

Remove the groove on both sides as indicated in the below pictures.



Put the panel back in by gluing it down on existing underfloor.

For post installation care of your floor, please read the Care and Maintenance instructions.

- Squeaking noises from the floor are typically caused by a lack of expansion around the perimeter or improper subfloor deflection. The lack of expansion will cause the planks to peak on the short ends, therefore, creating tension. The improper subfloor deflection will create movement/tension on the locking system.
- Lasting beauty can be achieved through purchasing a quality floor covering and providing proper ongoing maintenance.
- Furniture should be moved onto the newly installed floor using an appliance hand truck over hardboard runways.
- Avoid exposure to long periods of direct sunlight. The floor should not be exposed to direct sunlight for prolonged periods or temperature change to prevent the planks from peaking/bowing. Close blinds or drapes during peak sunlight hours. Floor covering subjected to excessive heat and light is subject to thermal degradation. Use appropriate precautions to minimize potential effects on the floor covering.
- Do not expose floors to temperatures exceeding 140° F for up to 6 hours.
- Oil or petroleum-based products can result in surface staining. Do not track asphalt-driveway sealer or automobile-oil drips onto the vinyl floor covering.
- Use non-staining mats. Rubber may discolor the floor.
- Caster wheeled chairs should have wide, rubber casters. Protective mats are required under office chairs.
- Frequently moved furniture should be equipped with felt pads to avoid scratching the floor. Heavy furniture and appliances should be equipped with non-staining large surface floor protectors. Furniture with castors or wheels must be easy swiveling, large surface non-staining and suitable for resilient floors. Do NOT use ball type castors as they can damage the floor.
- Use floor protectors under furniture.
- Use walk off-mats at entrances to prevent dirt and grit from being tracked onto the floor.
- Sweep or vacuum the floor regularly to remove loose dirt. Do NOT use vacuums that use a beater bar or turn the beater bar off.
- Do NOT use electric brooms with hard plastic bottoms with no padding.
- Clean up spills immediately.
- Damp-mop as needed using clean water and a diluted floor cleaner. Do NOT use harsh cleaners or chemicals on the floor. DO NOT use abrasive scrubbing tools. Do NOT use detergents, abrasive cleaners or "mop and shine" products.
- Vinyl Flooring, like other types of smooth floors, may become slippery when wet. Allow time for the floor to dry after washing.
- Immediately wipe up wet areas from spills, foreign substances, or wet feet.

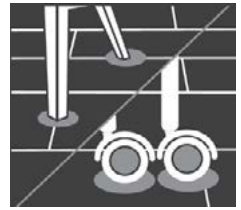

Use protective pads under furniture or equipment to reduce risk of surface damage. Please do not use rugs with rubber backing or carpets with vinyl floor.

RESIDENTIAL MAINTENANCE GUIDELINES

Newly Installed Floor Care

- Always use plywood or other boards when moving heavy objects across the floor.
- Sweep, dust mop, or vacuum the floor to remove all loose dirt and grit.
- Lightly damp mop with a well-wrung mop.

INITIAL & ROUTINE MAINTENANCE (DAILY OR AS NEEDED)

- Sweep, dust mop, or vacuum the floor to remove all loose dirt and grit. Do not use treated dust mops.
- Clean the floor using a properly diluted Neutral pH cleaner in cool water or ready-to-use spray cleaner that will not leave a residue such as Bona Professional Series Stone, Tile, and Laminate Cleaner in a pre-mixed spray bottle. Follow label instructions.

OVER TIME FLOOR CARE

Over time floors may begin to lose their luster and may require an application of floor polish. When and where you apply the floor, the polish will depend on the traffic the floor receives. A good quality floor polish like "Hilway Direct" can provide up to a year of protection in a high traffic area.

FLOOR POLISH APPLICATION DIRECTIONS:

1. Vacuum or dry sweep then damp mop floor to remove loose dirt and soil from the floor. Thoroughly scrub and clean the floor with a Neutral pH cleaner to remove all soil. Follow label Instructions.
2. Apply floor polish undiluted in a thin, even coat using a microfiber applicator mop. Do not use treated dust mops. Follow label instructions.
3. Apply 2-3 coats. Allow each coat to air dry completely (generally 30-60 minutes) before applying the next coat.
4. Allow floor surface to dry overnight before heavy traffic use.

PREVENTION

The single greatest cause of damage to any flooring or floor finish is abrasion from dirt and grit. Wherever possible, use walk-off mats at entrances and doorways. Use non-staining floor protectors under heavy furniture, chairs, and tables.

COMMERCIAL MAINTENANCE GUIDELINES

Safety Precautions

- When performing any wet maintenance, always put out wet floor signs and caution tape.
- When wet maintenance is finished and the floor is dry, remove all caution signs & tape.
- Carefully read and follow each product's label instructions for proper use.
- Refer to each product's MSDS for use of personal protective equipment.

NEWLY INSTALLED FLOOR CARE

- Always use plywood or other boards when moving heavy objects across the floor.
- Follow the Initial & Routine Maintenance instructions below.

INITIAL & ROUTINE MAINTENANCE (DAILY OR AS NEEDED)

- Sweep, dust mop or vacuum the floor to remove all loose dirt and grit. Do not use treated dust mops.
- Clean the floor using a properly diluted Neutral pH cleaner (Hilway Direct – Neutral Cleaner) in cool water. Follow label instructions.
- Mop or machine clean using 175-rpm "Swing-arm" machine or auto scrubber with a 3M 5100 Red pad (or equal). If the flooring has a painted bevel using a buffing machine can remove the painted bevel.
- Rinse the floor thoroughly with clean water and allow it to dry. Fans or air movers can speed up the drying time.

DAILY CLEANING DIRECTIONS:

- Sweep floor to remove loose dirt & soil.
- Using Mop & Bucket (2-bucket system) or Auto-Scrub Machine, dilute Hilway Direct Neutral Cleaner as directed on the product label. Mop floor with the cleaning solution.
- Trail mop excess soil and wet areas with a clean tightly wrung-out mop.
- No rinsing is required.
- Allow the floor to air dry completely.

Caution: Eye irritant. Avoid contact with skin and eyes. Do not taste or swallow. In case of contact with eyes or skin, flush with plenty of water. If irritation develops, seek medical attention. In case of ingestion, flush mouth with water, drink large quantities of water, and seek immediate medical attention, DO NOT induce vomiting.

KEEP OUT OF REACH OF CHILDREN.

Note: Avoid solution contact with sensitive surfaces such as wood, metal, furnishings. When applying the finish, avoid strong sunlight and drafts. Read full MSDS (available for download: www.hilway.com) and product label prior to use. Handling and Storage: Protect from freezing. Recommended storage temperature: 68°F (20°C). Avoid storing in direct sunlight and high temperatures. Do not store near food.

PERIODIC DEEP CLEANING

- Sweep, dust mop, or vacuum the floor to remove loose dirt and grit. Do not use treated dust mops.
- Machine scrub the floor using a properly diluted Neutral pH cleaner (Hilway Direct - Neutral Cleaner or mild Alkaline cleaner (Call 1-877-356-6748 for recommended cleaner) solution in cool water. Use a 3M 5300 Blue pad (or equal). Let solution stand for 5-10 minutes. Do not use a black or brown pad.
- Completely remove the cleaning solution with a wet-dry vacuum or auto scrubber and do not allow the solution to dry on the floor.
- Rinse the floor thoroughly with clean water and allow the floor to dry. Fans or air movers can speed up the drying time.

HILWAY DIRECT FLOOR FINISH - MATTE APPLICATION DIRECTIONS:

- Dry sweep followed by a damp mop to the floor to remove loose dirt and soil from the floor. Thoroughly clean the floor with Hilway Direct Neutral Cleaner or Allsafe Stripper.
- Remove any old site-applied acrylic coating. This usually can be done with Hilway Direct Allsafe Stripper diluted 1:5 or 1:10 with clean water, in an auto scrubber or low rpm swing machine with a red or blue pad or equivalent. Always rinse and neutralize the floor with clean water after removing the old coating. Do not let stripper solution dry on floor.
- Shake Hilway Direct Floor Finish - Matte vigorously for 30 seconds then let it settle for 5 minutes. Apply undiluted in a thin, even coat using a microfiber applicator mop. Do not use treated dust mops.
- Apply 2-3 coats. Allow each coat to air dry completely (generally 30-60 minutes) before applying the next coat.
- Allow floor surface to dry overnight before heavy traffic use.

Application Coverage: Undiluted, single coat: 1500 - 2000 square feet/ 1.33 gallons. Coverage may vary depending on the porosity of the flooring material.

For complete maintenance guidelines for your floor contact your local supplier.



STOP! READ!

ATTENTION! READ BEFORE INSTALLING!

ALL FLOOR COVERINGS SHOULD BE PROFESSIONALLY INSTALLED TO ENSURE A VALID WARRANTY.

We warrant all our products to be free from defects in material and workmanship, under normal use and service, for a specified length of time from the date of purchase as set forth below. This Limited Warranty only applies provided the flooring covered by this warranty is installed and maintained according to our Installation & Maintenance Manual.

WARRANTY COVERAGE 20 MIL.		
Structural	Residential	Light Commercial
Lifetime	Lifetime	10 Year

There are no warranties beyond this expressed limited warranty. All other warranties, including warranties of merchantability or fitness for a particular purpose are excluded. Manufacturer excludes any liability for lost profits and will not pay any other indirect, special, incidental or consequential damages under this warranty. By this we mean any loss, expense, or damage other than to the flooring itself that may result from a defect in the flooring. No implied warranties extend beyond the terms of this written warranty. The remedies contained herein are the only remedies available for breach of this warranty.

Please note: Some jurisdictions do not allow exclusion or limitations of incidental or consequential damages or limitations on how long an implied warranty lasts, so the above limitations or exclusions may not apply to you. Also note: This limited warranty gives you specific legal rights, and you may also have other rights which vary from jurisdiction to jurisdiction.

LIFETIME RESIDENTIAL WARRANTY

For residential installations, manufacturer warrants its regular (first quality) floor products to be free from manufacturing defects from the date of purchase; if installed according to the installation instructions and the approved application:

- Will not wear through
- Will not stain from common household stains
- Will not contain manufacturing defects
- Will not rip or tear from normal household use
- Will not permanently indent from normal household use
- Will not bottom-up discolor from underlayment panels (including lauan), as well as alkali, mold or mildew growth
- The edges of the flooring will not curl if subfloor conditions are met and maintained per the installation instructions

10 YEAR LIGHT COMMERCIAL WARRANTY

For commercial installations, Manufacturer warrants its regular (first quality) floor products are warranted to be free from manufacturing defects and will not wear through the printed image for the term length of the warranty coverage as set forth below in the Limited Warranty Term Length for Applicable Products and Years section, starting from the date of purchase, installed according to installation instructions and the approved application.

LIFETIME LIMITED STRUCTURAL WARRANTY

The floor plank is warranted to be water resistant and the structural integrity of the floor plank or tile will be significantly diminished by exposure to water for the life of the product. Moisture will affect the floor's integrity, when excessive moisture accumulates in buildings or on building materials, mold (and/or) mildew growth can occur (particularly if the moisture problem remains undiscovered or unaddressed). Manufacturer moisture warranty excludes damage resulting from mold and/or mildew growth due to prolonged exposure to moisture. In addition, such excessive moisture levels can cause the ends

and/or sides of the product to lift/flare due to the vapor pressure from underneath. Such damage from excessive moisture levels (as outlined in the installation instructions document) are not covered by this warranty. All sources of subfloor moisture should be remedied prior to installation. This warranty is not transferable by the purchaser of the floor.

Open joints of 0.01 inches (0.2 mm) or less are not considered a defect under the joint integrity warranty. Joints compromised by improper installation, lack of continuous climate control or obstructions creating pinch points are specifically excluded by this warranty.

This Lifetime Limited Structural Warranty excludes all casualty events involving water coming in contact with your floor and failures normally covered by homeowners insurance including, but not limited to, damages caused by flooding or standing water from leaky pipes, faucets, or household appliances. Also excluded are damages caused by flooding or standing water from hydrostatic pressure or other casualty events. Any damage to the subfloor and/or surrounding structure that is caused by standing water or flooding is not covered by this warranty.

When a defective product is installed, credit applies to material only and does not include labor since it is the responsibility of the installer to determine suitability of material prior to installation.

THIS LIFETIME LIMITED STRUCTURAL WARRANTY DOES NOT COVER:

- Damage to surrounding structure, walls, subfloor, fixtures, furniture, underlayment, moldings, trims, subfloor heating elements, or anything that is not the floor plank or tile.
- Damage resulting from mold & mildew growth due to prolonged exposure to moisture.
- Flooring that is installed outdoors.

WHAT IS NOT COVERED BY THIS LIMITED WARRANTY?

- Damage caused by fire, flooding, exposure to standing water or intentional abuse.
- Damage caused by moisture to surrounding structure, walls, subfloor, fixtures, furniture, underlayment, moldings, trims, subfloor heating elements, or anything that is not the structural integrity or dimensional stability of the floor plank or tile.
- Damage resulting from mold and mildew growth due to prolonged exposure to moisture. Moisture will affect the structure of the plank or tile, when excessive moisture accumulates (and in particular remains undiscovered or unaddressed) mold and/or mildew growth can occur.
- Flooring that is installed outdoors.
- Damage caused by vacuum cleaner beater bar, rolling caster wheels, and cutting from sharp objects. When vacuuming, we recommend using the wand attachment on your vacuum.
- Indentation or damage from improper loading including high heels, spiked shoes, rolling loads, chairs or other furniture not using floor protectors
- Damage caused by abuse such as moving appliances across the floor without adequate protection. When moving appliances or heavy furniture, lay a plywood panel on your floor and "walk" the item across it. This protects your floor from scuffing and tears.
- Loss of gloss/scratching.
- Minor color, shade or texture variations between samples or printed color photography and the actual material.
- Floors that are graded "irregular" or sold "as is" without warranty.
- Floors that are installed in structures other than owner-occupied or tenant-occupied residences. (Except products that are noted as warranted commercial or limited commercial.)
- Discoloration from moisture or underlayment panels after having been repaired or replaced by Manufacturer one time.
- Construction or installation-related damage – including installation defects due to installations not using the recommended Manufacturer products.
- Failure of the floor to adhere to the subfloor due to, for example, moisture, alkaline or vapor pressure from the subfloor.
- Inappropriate end-user activities.
- Damage due to adhesives or tape, scratches, gouges, scuffs, punctures, cuts, indentations, burns, accidents, lack of proper furniture rests, such as chair pads etc., rolling and/or non-foot traffic, or any intentional misuse of the product. Loss of

finish gloss over time is consistent with normal wear & tear and is not a product flaw.

- It is normal and expected for there to be color variations due to use of natural components, exposure to UV light and/or sunlight, and age of material. Therefore, color inconsistency between samples, replacement product or illustrations and actual product is not a manufacturing flaw.
- Manufacturer makes no guarantee that Manufacturer products will match or coordinate with customer furnishings, trim, cabinetry, railings, etc.
- Noncompliance with installation instructions and maintenance guidelines as recommended by Manufacturer.
- Manufacturer cannot assume responsibility for the suitability of flooring material and accompanying products for each individual installation as manufacturer has no control over the installer's proper application. Should an individual piece be doubtful as to appearance or dimension the installer should not use this piece.
- Cracking, warping, soiling, fading, improper maintenance or abuse caused by items such as roller skates, golf shoes, pets, or certain types of wheelchairs and other heavy rolling loads.
- Floor covering installed in inappropriate locations is excluded from this warranty.
- Gloss reduction or surface scratches are not considered surface wear. Dull finish can be corrected with spot or overall recoating care systems.
- Damage to floor caused by flooring that is installed using the floating method that subsequently is heated to temperature above 140°F (60°C) or is exposed to temperatures below 32°F (0°C). This product has an attached underlayment that is not suitable for a direct glue installation.
- If your site conditions fall outside of the specified temperature range, a dry-back vinyl plank installation is recommended.
- Sounds produced between the subfloor and the moisture barrier are considered a subfloor issue and are not covered under the product warranty.